

CUBER SERIES | ICE MACHINES



HOSHIZAKI

HOSHIZAKI. BEYOND STRONG.

hoshizakiamerica.com



HOSHIZAKI

CUBER SERIES | ICE MACHINES
THE CUBER SERIES

CHOOSING THE RIGHT ICE MAKER



HOW MUCH ICE DO YOU NEED?

Before choosing an ice maker, take a look at how many customers you serve and how many pounds of ice per person is needed depending on the industry.



Restaurants
use an average
of **2 lbs.** of ice per
customer per day

**Schools and university
cafeterias** average about
1.5 lbs. of ice per
student per day

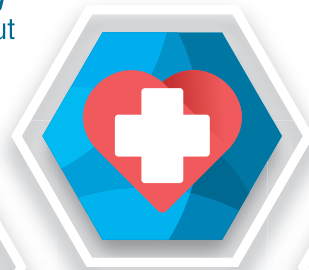

Hospital cafeterias
use about **1 lb.** of ice
per person per day

**Bars and cocktail
lounges** use
about **3 lbs.** of
ice per seat

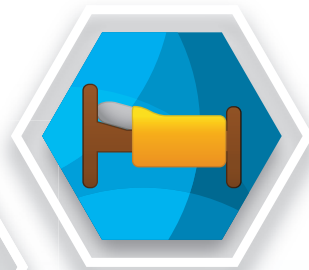

Hotels use
about **5 lbs.** of ice
per room per day

Volume of ice used

X

Number of
customers served

=

The type of ice
maker you need

Your menu should dictate
your machine—not the other way around

Visit
hoshizakiamerica.com
to find the ice machine
that's right for you



HOSHIZAKI

CUBER SERIES | ICE MACHINES TWO-SIDED STAINLESS STEEL EVAPORATOR

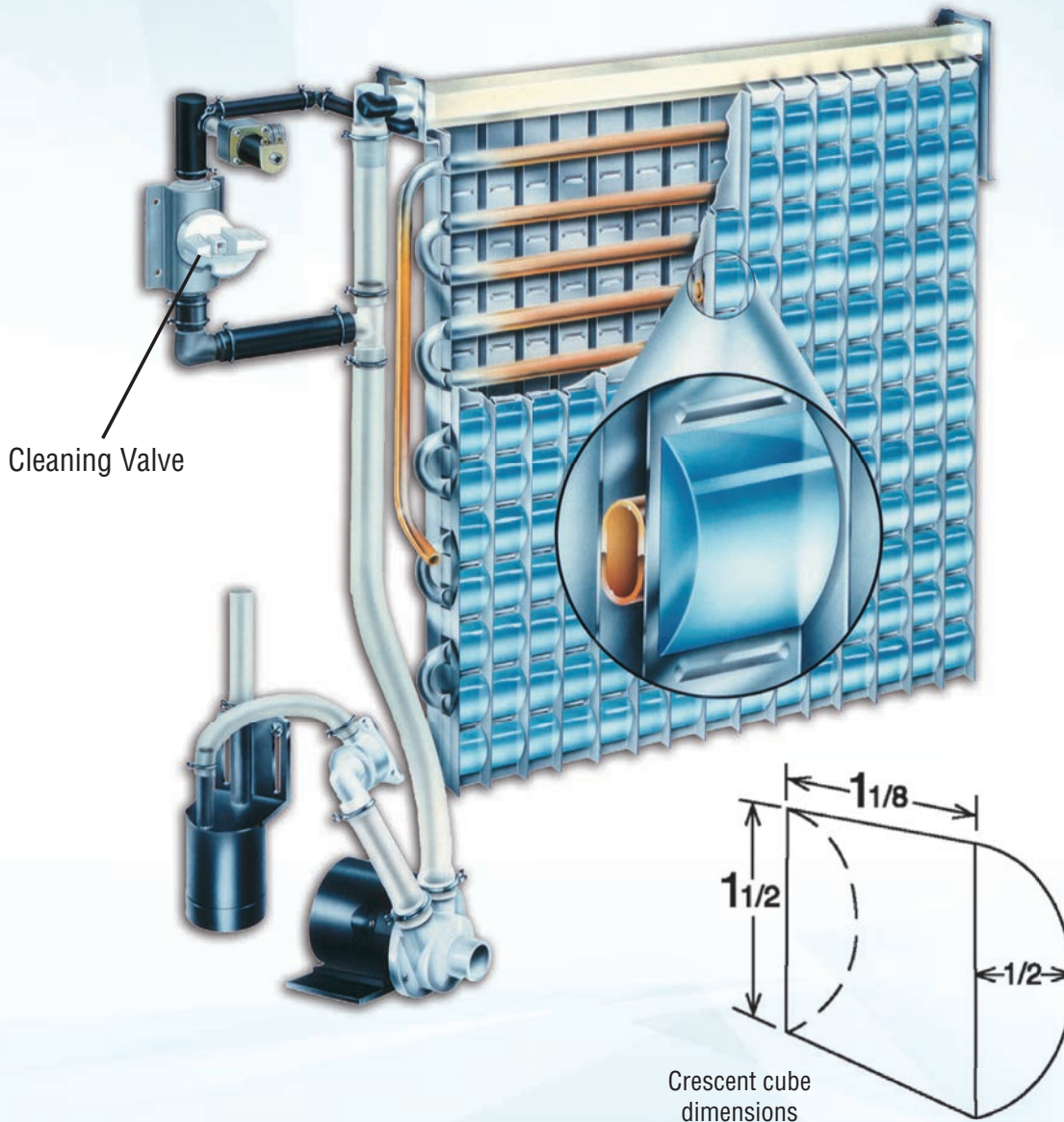

FEATURES

Unique two-sided stainless steel evaporator

Individual cubes

Optimum water flow

Removable water distribution channel

Cleaning valve

Automatic pump out

Built-in pre-chiling

Water tank

BENEFITS

Smooth, durable surface makes twice as much ice per cycle

Consistent cube size
- No adjustments
- No clusters to break-up

Washes out minerals for crystal clear, harder cubes

Easy cleaning

Cleans water inlet circuit through evaporator

Removes mineral build-up

Increased energy efficiency

One batch of water per one batch of ice, optimizing electricity and water efficiency



HOSHIZAKI

CUBER SERIES | ICE MACHINES INDIVIDUAL CRESCENT CUBES



**HOSHIZAKI
CRESCENT CUBE**

EVAPORATOR DESIGN

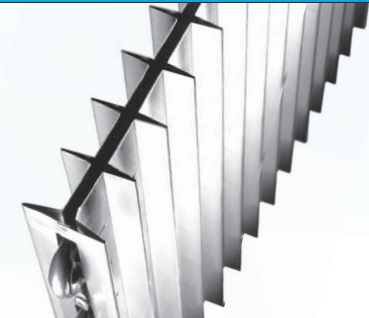

Double-sided, smooth, stainless steel continuous surface makes the same amount of ice in half as many cycles.

ICE CREATION

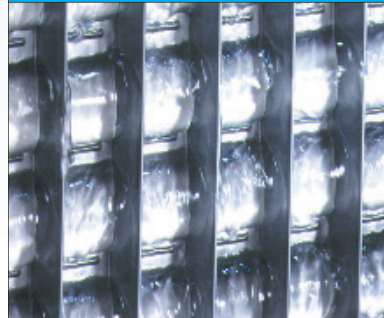

Impurities are flushed away each cycle leaving hard, crystal-clear ice that lasts longer and has better displacement.

HARVEST

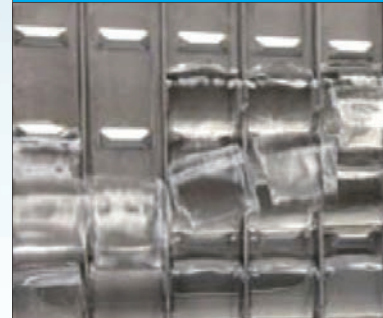

Crescent cubes come off individually for consistent cube size and no ice clusters.

CLEANING



Flat, open stainless steel surface stays clean and is easy to service for longer life and reliability.



**COMPETITOR GRID CELL
RHOMBOID CUBE**



Plated metal that is welded into a grid can chip and peel over time due to expansion and contraction.



Turbulent water over the grid cell design traps air and impurities causing soft, cloudy ice that melts faster.

Blue represents impurities trapped in ice.

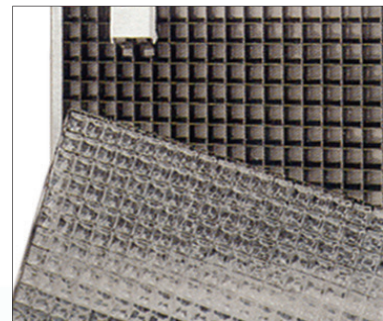

Ice cubes come off as one big sheet leaving clusters that don't fit in cups/glasses.



Grid is difficult to clean. A dirty evaporator can cause diminished production, increased service cost and premature equipment failure.



HOSHIZAKI

HOSHIZAKI KM Cubers will produce more ice, using less energy and cycling half as many times as the competition. The CycleSaver™ design means longer life, less maintenance, and increased customer profits.

It will take a HOSHIZAKI Ice Machine 15 years to accumulate as many cycles as the competition in 6 years.



KM-1301SAH



CUBER SERIES | ICE MACHINES CYCLESaver™

CYCLES PER YEAR

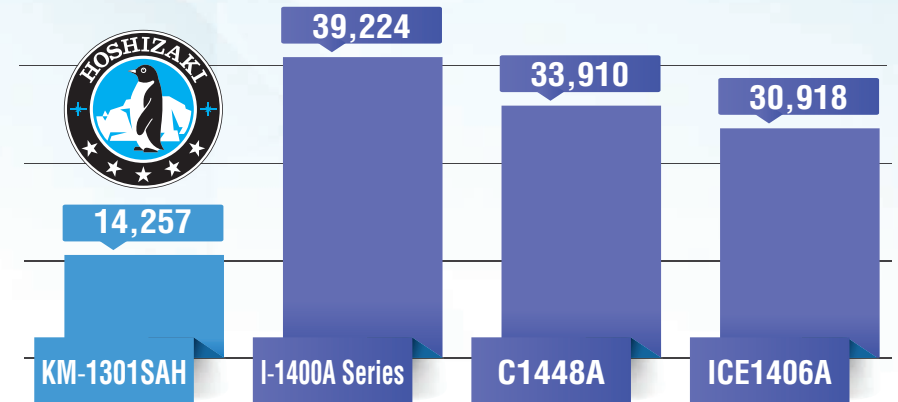

WATER AND ELECTRICAL USAGE

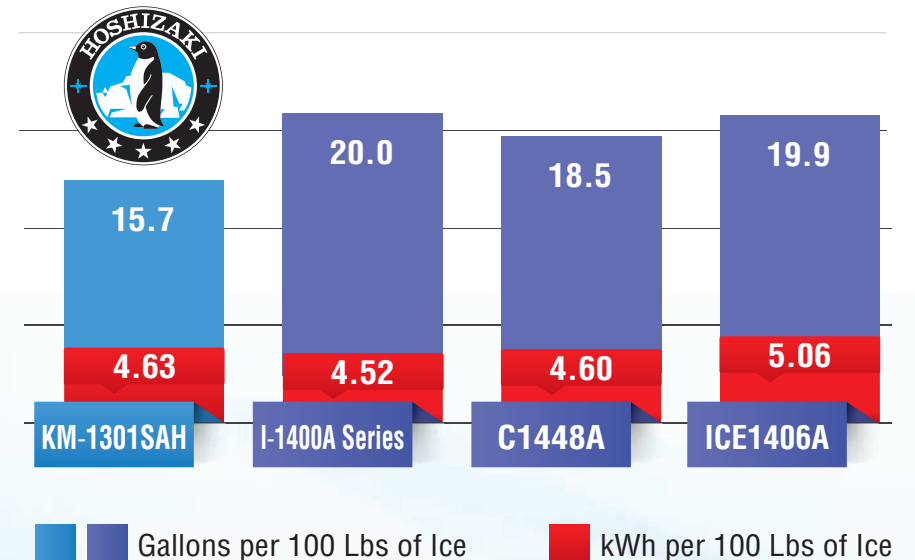



HOSHIZAKI

CUBER SERIES | ICE MACHINES FULLY COMPARTMENTALIZED DESIGN

The compartmentalization of HOSHIZAKI Cubers greatly improves reliability and sanitation. The cold and wet areas are insulated and separated from electrical and heat producing components. These design features also increase efficiency and reduce maintenance and service cost.



**Sealed,
Insulated Evaporator
Compartment**

**Dry Electrical
and Compressor
Compartment**

**Dry Pump
Compartment**

**Insulated
Ice Drop
Compartment**

FEATURES

BENEFITS

ABS foam insulated evaporator housing

Increased efficiency

Sealed evaporator compartment

Protects evaporator from environment

- Excellent sanitation
- Bacteria/slime growth reduced
- Less frequent cleaning

Isolated compressor compartment

Protects compressor from condensation

- Keeps compressor heat from the ice making and storage areas

Isolated pump motor

Protects pump motor winding from moisture and condensation

Serviceable from front

Saves time diagnosing and servicing

- Less expensive service calls

Isolated electrical components

Prevent moisture related electrical failures

Removable, cleanable air filters

Protects machine and interior components from:

- Dust
- Flour
- Lint
- Grease

Reduces maintenance costs
Extends machine life



HOSHIZAKI

The state of the art design of HOSHIZAKI Ice Machines have improved serviceability:

By eliminating the problem areas such as complicated electronic controls, plated surface evaporators, extrusions, and critical adjustments, our machines are considerably easier to diagnose.

Easy access - the majority of all service and maintenance can be accomplished from the front of the unit.

These controls are located in a dry environment, greatly improving electrical component reliability.

HOSHIZAKI Cubers feature the EverCheck™ Control Board, with audible alarm and diagnostic features; designed to assist service technicians in diagnosing problems.

CUBER SERIES | ICE MACHINES SIMPLE CONTROLS

FEATURES

Float switch control terminates freeze cycle

Automatic water safety shut off

Thermistor controlled termination

Three point check diagnosis

Ten or fifteen minute cycle check

High temp lock out

BENEFITS

Consistent ice formation under all ambient conditions

Protection from water loss, or filter restriction

Eliminates mechanical moving parts: less down time, fewer repairs, longer life

Easy to troubleshoot

Quick diagnosis

Protects refrigeration components and prevents failures





HOSHIZAKI

The benefits water filtration delivers to a foodservice operation affects the success of your business every single day. HOSHIZAKI water filters keep your equipment running smoothly while maximizing its efficiency. Water filtration improves the taste of the drinks you serve and delivers consistent results every time. Water filtration provides operators with the peace of mind that their water is the best it can be.



H-GUARD Plus[®] Antimicrobial Agent is embedded in the ice machine key components; it inhibits the growth of bacterial, mold, and other microorganisms.

CUBER SERIES | ICE MACHINES FILTERS / ANTIMICROBIAL

FEATURES

Water filtration available in single, twin, and triple configurations

BENEFITS

Keeps ice machine functioning at full capacity

Reduces up to 99.9% of disinfectant chlorine from incoming water supply

Maximizes efficiency

Improves beverage taste and ensures consistent results

Hoshizaki Water Filters
(Optional Accessory)





HOSHIZAKI

CUBER SERIES | ICE MACHINES WARRANTY

Warranty

- 3 Year Warranty parts and labor for the entire unit
- 5 Year Warranty parts and labor for the evaporator
- 5 Year Warranty parts for the compressor and air-cooled condenser
- QR Code on each unit for easy access to warranty and service information



Warranties are valid in the United States, Puerto Rico, & U.S. Territories only. Contact factory for warranty information in other Countries. Refer to manufacturer's full warranty for complete details.

Please visit our website, hoshizakiamerica.com to find additional information regarding Hoshizaki's full line of equipment and services, including training schools and factory tours, that are available.

Customer Commitment

Our commitment to quality continues after the sale. To ensure your HOSHIZAKI equipment operates at its optimum level, we provide the following:

- An established field service network
- Toll-Free Technical Support Line 24 hours, 7 days a week, including holidays - 800-233-1940
- Multi-level training
www.hoshizakiamerica.com/training





HOSHIZAKI

CUBER SERIES | ICE MACHINES
COMPETITIVE ADVANTAGE

HOSHIZAKI



Competitors

Stainless Steel ice making surface

Plated metal, welded ice making surface

Individual Clear Cubes

Grid cell slabs of cloudy ice

Simple Controls



Complicated control board

CycleSaver™



Compressor works 2-4 times harder for same amount of ice

Hard ice lasts longer – better tasting drinks

Softer ice – melts faster



HOSHIZAKI

HOSHIZAKI's large square cube ice machines are ideal for upscale restaurants and bars. This specialty ice gives the perfect amount of chill for cocktails. With two different ENERGY STAR® qualified options in our IM line, choose the convenience of an undercounter model or the increased production of the stackable IM-500SAA on a bin.

CUBER SERIES | ICE MACHINES IM SQUARE CUBERS

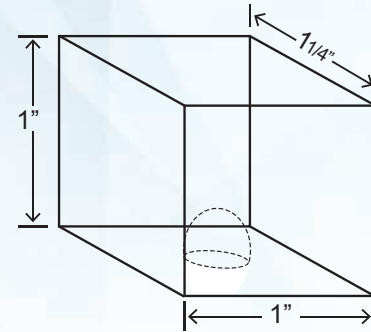

IM square ice dimensions



IM-200BAA



**IM-500SAA
on B-700SF**



Peachtree City, GA
Corporate Headquarters & Manufacturing

HOSHIZAKI is a global leader in the design, manufacturing, and marketing of equipment for the foodservice industry. With their corporate office located in Peachtree City, Georgia, HOSHIZAKI produces the highest level of excellence in ice machines and refrigeration equipment. Delivering continuous innovation, durability and style, the HOSHIZAKI name is synonymous with reliability and customer commitment.



Griffin, GA
Manufacturing



HOSHIZAKI

HOSHIZAKI. BEYOND STRONG.

HOSHIZAKI AMERICA, INC.

618 Highway 74 South, Peachtree City, GA 30269

Toll Free: (800) 438-6087 | Fax: (800) 345-1325

hoshizakiamerica.com



03/28/2017 | Item #40039

