



DCM-300BAH-OS

OPTI-SERVE SERIES SANITARY CUBELET ICE MACHINE/DISPENSER



DCM-300BAH-OS
03/31/17
Item # 13285

Item #: _____
Project: _____
Qty: _____
AIA#: _____

Features

- ▶ Durable stainless steel exterior
- ▶ Advanced CleanCycle24™ design 
- ▶ Stainless steel auger with greaseless bearing

- Up to 321 lbs. of ice production per 24 hours, with 40 lbs.* built-in storage
- 2 second flush cycle every hour
- Corrosion resistant stainless steel exterior
- Easy to chew, cubelet ice
- Self-contained design reduces opportunities for cross contamination
- Protected by H-GUARD Plus Antimicrobial Agent 
- Dispenses ice and water
- R-404A Refrigerant

Warranty:

3 Year Parts & Labor on entire machine.
5 Year Parts on Compressor; air-cooled condenser coil.
Valid in United States, Canada, Puerto Rico and U.S. Territories. Contact factory for warranty in other countries.

*Rated in accordance with AHRI Standard 820 (I-P)

W x D x H 26" x 22 ¹ / ₂ " x 40"
SD-450 26 ¹ / ₄ " x 22" x 32 ¹ / ₂ "
SD-500 25 ⁷ / ₈ " x 22" x 32 ³ / ₄ "



DCM-300BAH-OS
Air-Cooled
Shown with optional
SD-500 Stand

**Hands-free sensor designed for use
with opaque containers.
Not intended for outdoor use - avoid
placement in direct sunlight.*



Condenser	Model	ICE PRODUCTION		Type of Ice (Hardness Rating)	WATER USAGE		kWh Used per 100 lbs. 90°/70°F	ELECTRICAL			Heat Rejection BTU/hr.	Shipping Weight	ENERGY STAR®
		Air / Water Temp Lbs. per 24 hours 70°/50°F 90°/70°F			Potable Gal. per 100 lbs. 90°/70°F	Condenser Gal. per 100 lbs. 90°/70°F		Max. Fuse Size or HACR Circuit Breaker	Amperage	Voltage			
Air-Cooled	DCM-300BAH-OS	321	232	Cubelet (88)	12.5	N/A	6.84	20A	10.25A	115V/60/1	3,500	240 lbs.	

Cubelet Dimensions*

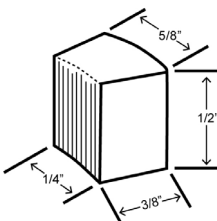

* approximate size in inches, image not to scale

Operating Limits

- Ambient Temp Range 45 - 100°F
- Water Temp Range 45 - 90°F
- Water Pressure 10 - 113 PSIG
- Voltage Range 104 - 127V

Service

- Allow 6" (15 cm) clearance at rear and sides for proper air circulation and ease of maintenance/service should they be required. Allow 24" (61 cm) clearance at top to allow for removal of the auger.

Not intended for outdoor use - avoid placement in direct sunlight.

Plumbing

- Icemaker Water Supply Line: Minimum 1/4" Nominal ID Copper Water Tubing or Equivalent
- Icemaker Drain Line: Minimum 3/4" Nominal ID Hard Pipe or Equivalent



DCM-300BAH-OS

OPTI-SERVE SERIES
SANITARY CUBELET ICE MACHINE/DISPENSER

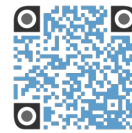

DCM-300BAH-OS
03/31/17
Item # 13285

FRONT VIEW

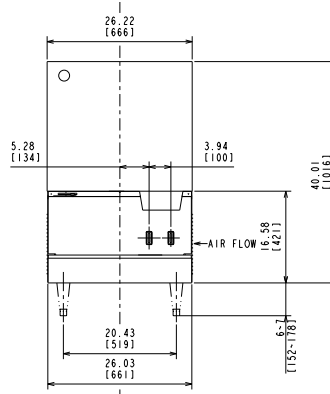

inch
[mm]

AIR-COOLED

SIDE VIEW

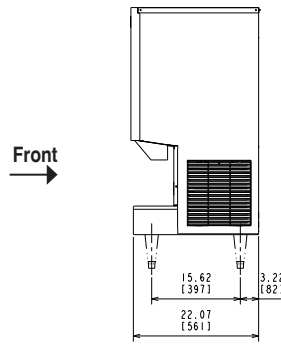

AIR-COOLED

REAR VIEW

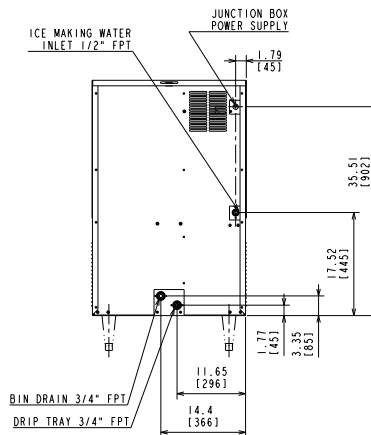

AIR-COOLED

TOP VIEW

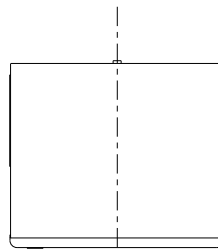

Front

AIR-COOLED